

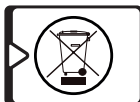

Prolaser® Cross Line Laser

Model No. 852G

User Manual

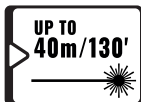

Thank you for purchasing Kapro's 852G GREEN Prolaser® Cross Line. You now own one of the most advanced laser tools available. This manual will show you how to get the most out of your laser tool.

APPLICATIONS

The 852G GREEN Prolaser® Cross Line is innovatively designed for a very broad range of professional and DIY jobs, including:

- Aligning tiles, cabinets, borders, moldings and trimmings
- Doors and windows installation
- All types of DIY jobs, including hanging shelves, pictures and more

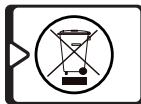
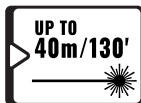

NOTE

Keep this user manual for future reference.

CONTENTS

• Features	4
• Safety instructions	5-6
• Battery installation & Safety	7-8
• Overview	9
• Operating instructions	10-12
• Maintenance	13
• Field calibration test	14-19
• Specifications	20
• Warranty	21



FEATURES

- Automatically determine the horizontal and vertical plains
- Intersecting horizontal and vertical line projection
- Self-level in automatic mode when the laser is positioned within its self-leveling range
- Visual “out of leveling range” warning
- Pulse mode - emits pulses that can be detected by a detector
- The max. detectable range of the laser in pulse mode is 40m (130')
- Manual mode allows angular layout/marking
- Locking mechanism to protect the pendulum during transportation
- 1/4" tripod adaptor
- Shock resistant rubberised casing
- Compact size – fits in your toolbox

NOTE

This device contain precision components that are sensitive to external shock, impact or drop that may compromise its functionality –handle with care to maintain its accuracy.

SAFETY INSTRUCTIONS



WARNING

**This product is emitting radiation that is classified
As class II according to EN 60825 -1**

The laser radiation can cause serious eye injury



- Do not stare into the laser beam
- Do not position the laser beam so that it unintentionally blinds you or others.
- Do not operate the laser level near children or let children operate the laser level.
- Do not look into a laser beam using magnifying optical devices such as binoculars or a telescope, as this will increase the level of eye injury.

! **WARNING:** This product contains lead in solder and certain Electrical parts contain chemicals which are known to the State of California to cause cancer, birth defects or other Reproductive harm.

(California Health & Safety Code Section 25249.6- Proposition 65)



NOTE

**The green goggles are intended to enhance the
visibility of the laser beam. They will not protect
your eyes against laser radiation.**



- Do not remove or deface warning labels on the laser level
- Do not disassemble the laser level. Laser radiation can cause serious eye injury
- Do not drop the laser
- Do not use solvents to clean the laser
- Do not use in temperatures below -10°C or above 45°C (14°F / 113°F)
- Do not operate the laser in explosive atmospheres such as flammable liquids, gases or dust sparks from the tool can cause ignition
- When not in use, turn off the power, engage the pendulum lock and place the laser in the carrying pouch
- Make sure the pendulum lock mechanism is engaged before transporting the laser

NOTE

If the pendulum lock mechanism is not engaged before transportation, internal mechanical damage can occur.

BATTERY INSTALLATION & SAFETY

1. Press down on the latch and open the battery cover.
2. Insert 3 new AA batteries of the same brand according to the polarity diagram on the inside of the battery cover.
3. Close the battery cover.



Lithium-Ion Battery (optional) Installation

1. Press down on the latch to open the battery cover.
2. Insert a fully charged Li-Ion battery according to the polarity diagram on the inside of the battery cover.
3. Close the battery cover.
4. Can be charged with any 5V charger and Type-C USB cable.



NOTE

If the laser level will not be used for a long period, remove the batteries from the battery compartment. This will prevent batteries from leaking and corrosion damage.



WARNING: Batteries can deteriorate, leak or explode, and can cause injury or fire.

1. Do not shorten the battery terminals.
2. Do not charge Alkaline batteries.
3. Do not mix old and new batteries.
4. Do not dispose of batteries into household waste.
5. Do not dispose batteries in fire.
6. Defective or dead batteries must be disposed according to local regulations.
7. Keep the batteries out of reach of children.

OVERVIEW

1. On/Off Locking Switch

2. Keypad

- a. Pulse Mode button
- b. Beam Selector button
- c. Manual Mode button

3. Laser output window

4. Battery cover

5. 1/4" tripod mount

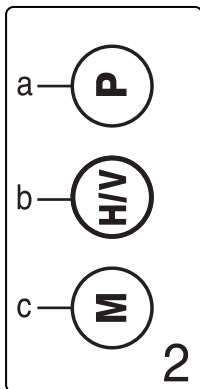
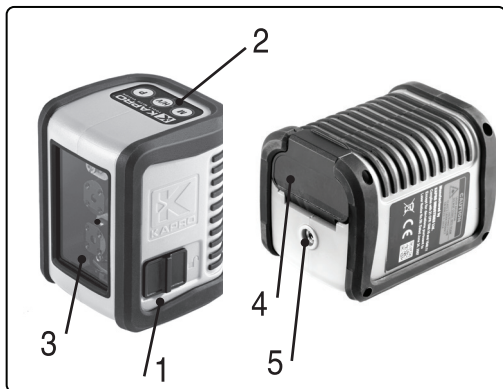

Working in Automatic mode (self-leveling):

In automatic mode the laser level will level itself in the range of $\pm 3^\circ$ and will project a horizontal line, vertical line or both lines simultaneously.

1. Remove the laser from its case and place it on a solid, flat, vibration free surface or on a tripod.
2. Slide the locking switch #1 to the **ON** position. The laser level will generate the crossed horizontal and vertical lines.
3. Choose the beams that you want to work with by pressing the **H/V** button.
4. If the initial slope of the laser is beyond $\pm 3^\circ$ and the automatic mode is activated, the laser lines will flash. In this case, reposition the laser on a leveled surface.
5. Before moving the laser level, switch the laser to **OFF**. This will lock the pendulum and protect your laser.

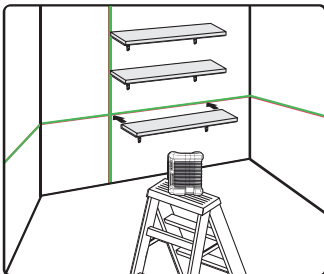

Working in Manual mode:

In Manual mode, the 852G's self-leveling mechanism is disabled and the laser lines can be set at any slope required. The laser beams will flash every 3 seconds to let you know that you are working without the self-leveling and the beams may not be leveled.

1. Press the Manual push button mode **M**. The laser will project the cross lines.
2. Choose the beams that you want to work with by pushing the Beam Selector push button **H/V**.
3. To mark a slope, tilt the laser using to reach the required angle.
4. To turn the manual mode off, press again the Manual push button **M**.
5. While in Manual mode sliding the locking switch #1 from **OFF** to **ON** will turn off the Manual mode. The automatic self – leveling will be activated if the laser level is within the self – leveling range.

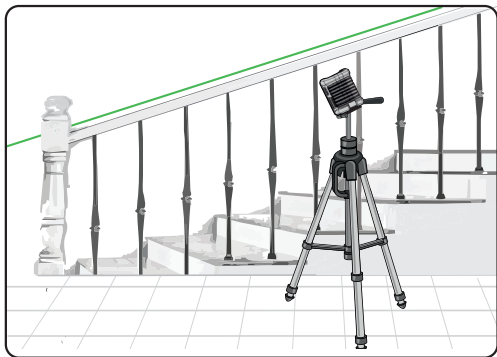

Working in Pulse mode with a detector:

For outdoor work under direct sunlight, or bright light conditions, and for extended indoor ranges up to 40 meters, use the Pulse mode with a detector.

When the pulse mode is activated, the laser lines will flash at a very high frequency (invisible to the human eye). This will allow the detector to detect the laser lines. The pulse mode can be activated in both Automatic and Manual modes.

1. To turn the Pulse mode on, press the **P** button.
2. When activated, a slight reduction in laser line brightness will occur.
3. To turn the Pulse mode off, press the **P** button again.
4. Laser lines brightness will return to previous brightness.

MAINTENANCE

To maintain the accuracy of your project, check the accuracy of your laser level according to the field calibration tests procedures.

- Change the batteries when the laser beams begin to dim.
- Wipe the aperture lens and the body of the laser level with a clean soft cloth. Do not use solvents.
- Although the laser level is dust and dirt resistant to a certain degree, do not store in dusty places as a long term exposure may damage internal moving parts.
- If the laser level is exposed to water, dry the laser level before returning it to the carrying case to prevent corrosion damages.
- Remove the batteries if the laser level is not used for a long period of time to prevent corrosion damages.

This laser level left the factory fully calibrated.

Kapro recommends that the user will check the accuracy of the laser periodically, or if the unit falls or is mishandled.

To do so first check the height accuracy of the horizontal line, then check the levelling accuracy of the horizontal line, and finally check the leveling accuracy of the vertical line.

Checking the Height Accuracy of the Horizontal Line.

(Up and down deviation)

- 1) Set up the laser on a tripod or on a solid surface between two walls **A** and **B**, approximately 5 meters apart.
- 2) Position the laser level approximately 0.5 meter from wall **A**
- 3) Unlock the pendulum and press the button to project the horizontal and the vertical cross lines towards wall **A**.
- 4) Mark on the wall the center of the cross lines as **a1** (see figure # 1).

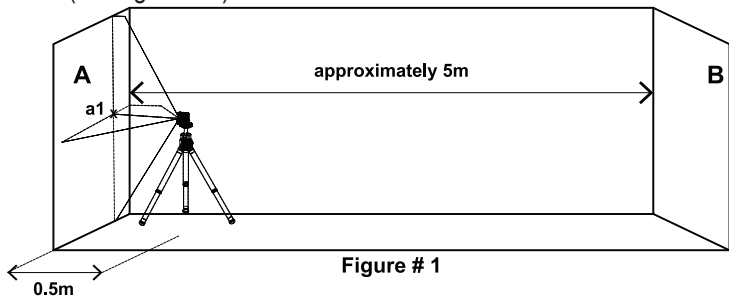

Figure # 1

- 5) Turn the laser 180° towards wall **B**, and mark on the wall the center of the cross lines as **b1** (see figure 2).

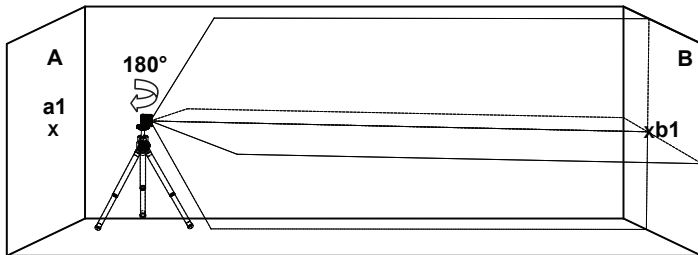

Figure # 2

- 6) Move the laser level towards wall **B** and position it approximately 0.5 meter from wall **B**.
- 7) Mark on wall **B** the center of the cross lines as **b2** (see figure 3).

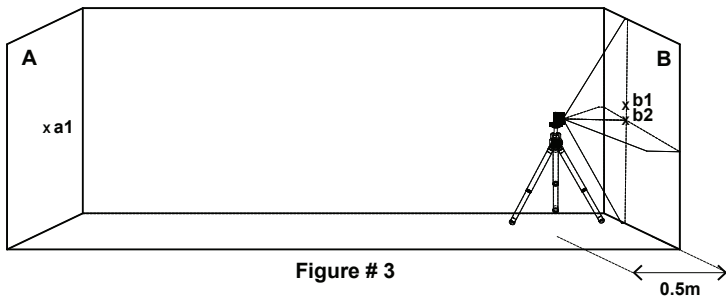

Figure # 3

- 8) Turn the laser 180° towards wall **A**, and mark on the wall the center of the cross lines as **a2** (see figure 4).

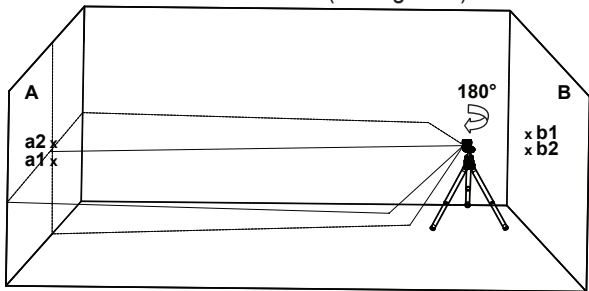

Figure # 4

- 9) Measure the distances:

$$\Delta a = |a2 - a1|$$

$$\Delta b = |b1 - b2|$$

- 10) The difference $|\Delta a - \Delta b|$ should not be more than 3 mm, otherwise to send the laser level to a qualified technician for repairs.

Checking the Level Accuracy of Horizontal Line.

(Side to side inclination)

- 1) Set up the laser on a tripod or on a solid surface at a distance of approximately 1.5 meters from a wall 5 meter long.
- 2) Unlock the pendulum and press the button to project the horizontal and the vertical cross lines towards the wall.

- 3) Mark point **a1** on the wall, in the middle of the horizontal line at the left edge of the horizontal line (see figure 5).

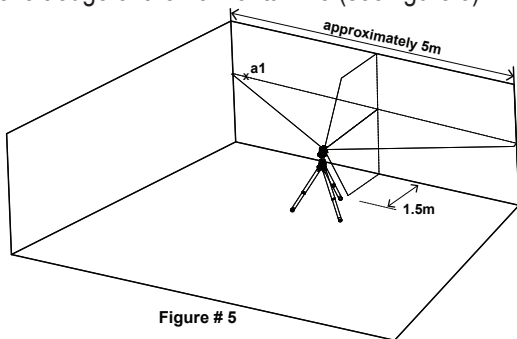

Figure # 5

- 4) Turn the laser level counterclockwise until the right edge of the horizontal line reach's near **a1**, mark a point **a2** on the wall in the middle of the horizontal line (see figure 6).

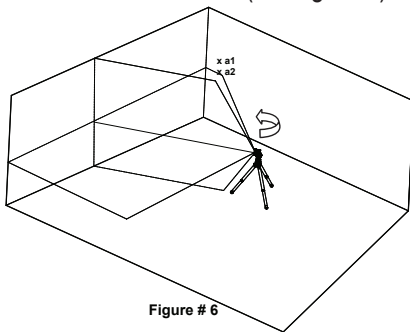
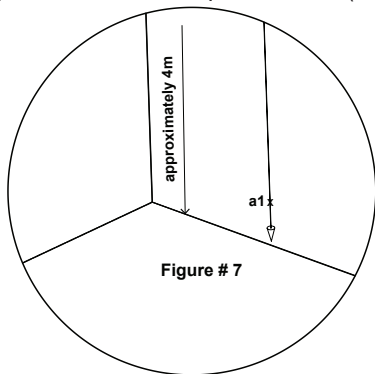

Figure # 6

- 5) The distance between **a1** and **a2**, should not be more than 1.5mm otherwise to send the laser level to a qualified technician for repairs.

Checking the Accuracy of the Vertical line.

- 1) Hang approximately 4 meter plumb line on a wall.
- 2) After the plumb line has settled, Mark point **a1** on the wall behind the plumb line near the plumb cone. (see figure 7).



- 3) Set up the laser on a tripod or on a solid surface in front of the wall at a distance of approximately 2 meters.
- 4) Unlock the pendulum, and press the button to project the vertical line toward the plumb line.
- 5) Turn the laser so that the vertical line will merge with the plumb line below the hanging point.

- 6) Mark point **a2** on the wall, in the middle of the vertical line at the same height of **a1**. (see figure 8).

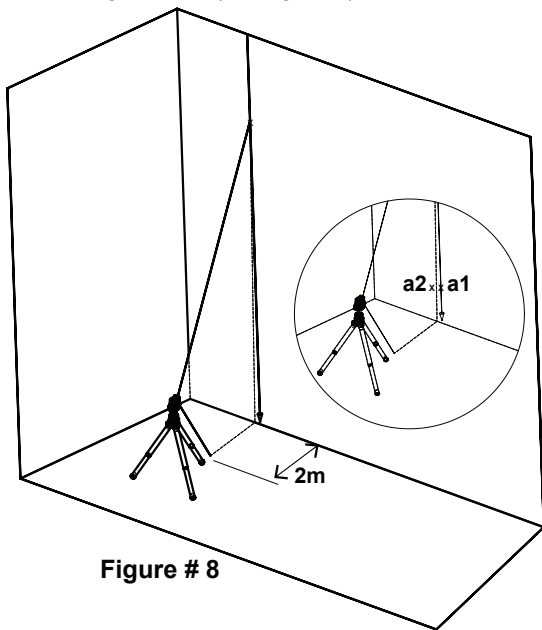

Figure # 8

- 7) The distance between **a1** and **a2**, should not be more than 1.5mm, otherwise to send the laser level to a qualified technician for repairs.



SPECIFICATIONS

Laser beams output pattern	Vertical and horizontal cross lines Horizontal line Vertical line
Laser range	<ul style="list-style-type: none">• Indoor - up to 20m (65ft)• Outdoor with detector up to 40m (130ft)
Accuracy	$\pm 0.3\text{mm/m}$ ($\pm 0.0003\text{in/in}$)
Fan angle	$120^\circ \pm 5^\circ$
Self-leveling range	$\pm 3^\circ$
Laser line width	2 mm \pm 0.5mm/5m (0.10" \pm 0.02" at 20')
Wavelength	515 \pm 5nm - Laser Class II
Power supply	3 AA batteries included 3.7V Li-Ion battery pack (optional)
Battery life	up to 15 hours of continuous operation Li-Ion battery pack – up to 7hr
Operating temp	-10° C + 45° C (14°F +113°F)
Storage temp	-20° C +70° C (-4°F +140°F)
Water & dust proof	IP54
Dimensions	8.6cm x 6.4cm x 6.6cm (3.4" x 2.5" x 2.6")
Weight included batteries	280gr \pm 10gr (0.6lbs \pm 0.35oz)

WARRANTY

This product is covered by a two-year limited warranty against defects in materials and workmanship. It does not cover products that are used improperly, altered or repaired without Kapro approval.

In the event of a problem with the laser level you have purchased, please return the product to the place of purchase with the proof of purchase.

Model #852G

Serial number sticker is positioned on the battery compartment lid.

CE CONFORMITY CERTIFICATE

This product meets the standards of the Electromagnetic Compatibility (EMC) established by the European Directive 2014/30/EU and the Low Voltage Directive (LVD) 2014/35/EU

EC DECLARATION OF CONFORMITY

We declare under our responsibility that the product 852G is in accordance with the requirements of the Community Directives and Regulations:

2014/30/EU

2011/65/EU

EN60825-1: 2014

EN61326-1: 2013